

5400 Data Court | Ann Arbor, Michigan 48108 U.S.A.  
Phone: 844-411-3533 | E-Mail: fleetreps@4are.com  
Web: www.4are.com/fleet/build | www.truck-hero.com



**ATTN: STATE OF CALIFORNIA CONSUMERS**  
**WARNING:** Cancer and Reproductive Harm - www.P65Warnings.ca.gov.  
Products in this brochure are subject to California Prop 65.

Form #690 02/20

# FLEET & COMMERCIAL PRODUCTS



Outfit for Work®

# TABLE OF CONTENTS

## COMMERCIAL CAPS

A.R.E. DCU .....	3-8
A.R.E. DCU MAX .....	3-8
A.R.E. DCU DIAMOND EDITION .....	3-8
A.R.E. HD .....	9-11
A.R.E. TOOLMASTER .....	12-14

## TRUCK BED COVERS

A.R.E. DOUBLECOVER & FUSION .....	15
A.R.E. 3DL & LSII .....	16
BAK MX4, REVOLVER X4, X2 & BAKBOX 2 .....	17
TRUXEDO LO PRO & TRUXPORT .....	18
EXTANG XCEED & SOLID FOLD 2.0 .....	19
RETRAX ONE MX & POWERTRAX PRO MX .....	20
ROLL-N-LOCK M-SERIES .....	20
UNDERCOVER SE .....	21
TRUCK HERO ELEVATE RACK SYSTEM .....	22

## ACCESSORIES

BEDRUG BEDTRED ULTRA & BEDRUG XLT MAT .....	23
BEDRUG VANRUG & VANTRED .....	23
HUSKY LINERS WEATHERBEATER .....	24
HUSKY LINERS MUD GUARDS .....	24
HUSKY LINERS X-ACT FLOOR LINERS .....	24
HUSKY LINERS MUDDOG MUD FLAPS .....	24
AMP POWER STEPS .....	25
SUPERLIFT FENDER FLARES .....	25
RUGGED LINER WHEEL WELLS .....	26
BUSHWACKER RIVET STYLE & SMOOTH FINISH .....	26
N-FAB GROWLER FLEET STEPS & PODIUM STEPS .....	27
CARGOGLIDE .....	28
TRUCKVAULT .....	29
RIVAL LIGHTING BY A.R.E. ....	30



## COMMERCIAL CAPS Aluminum vs. Fiberglass

### WHY ALUMINUM?

1. FULLY CUSTOMIZABLE
2. STRENGTH AND DURABILITY
3. BUILT FOR THE TOUGHEST JOBS

### WHY FIBERGLASS?

1. CUSTOM MOLDED
2. SLEEK AND STYLISH DESIGN
3. COLOR MATCHED TO TRUCK





# GET TO WORK WITH A COMMERCIAL ALUMINUM CAP



## The Right Tool for Your Truck

A.R.E.'s rugged welded frame construction offers years of durable service, no matter what the weather or job. Each unit has weather-sealed doors with gas props, heavy-duty hinges, and automotive-style locks to protect your valuables.

**BUILD ONLINE**  
[www.4are.com/fleet/build](http://www.4are.com/fleet/build)

# Build Your Perfect Commercial Aluminum Cap

Follow these 12 steps and check options clearly.  Consult your local A.R.E. dealer for more details or with questions regarding any of the options shown here.

## 1 Choose Your Model



### DCU (.035")

- Strength and durability for everyday use
- Heavy-duty .035" aluminum skin
- Standard 1/2 rear door
- Standard full length side door
- Available in wedge style
- Galvanized steel toolboxes with baked white coating

## DCU MAX™



### DCU MAX (.063")

- Increased strength and durability for the toughest work environments
- Heavy-duty .063" aluminum skin
- Stainless steel strap hinges on double or single full doors
- Galvanized steel toolboxes with baked white coating



### DE Diamond Edition DCU (.063" Diamond Plate)

- Increased strength and durability for the toughest work environments with added style
- Heavy-duty .063" diamond plate aluminum skin
- Stainless steel strap hinges on double or single full doors
- Diamond plate toolboxes

## 2 Choose a Cap Height

A. Select the appropriate height for your needs. Consider headroom, accessibility and the amount of overall space you need.

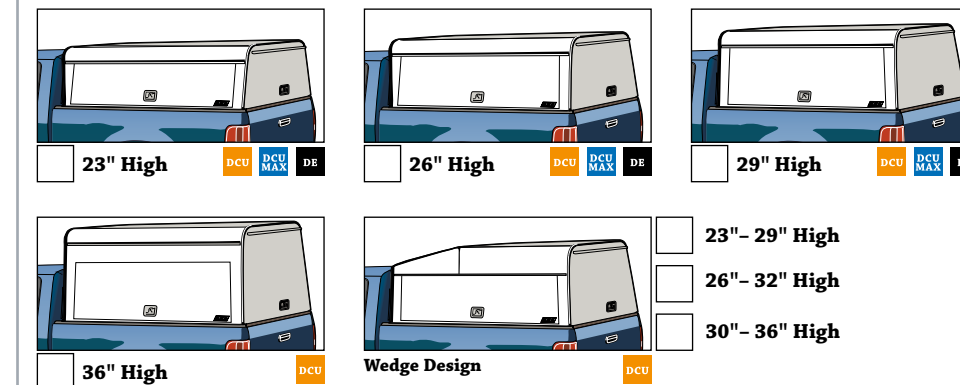

## 3 Choose a Color and Interior Options

A. Choose from one of our standard colors or have your cap painted to match the truck manufacturer's paint code.



B. Choose from our interior upgrade options based on your needs for added security, strength or insulation.

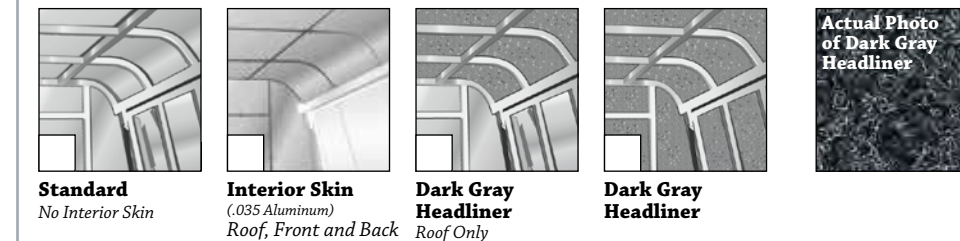

C. Choose a roof vent for increased air circulation.

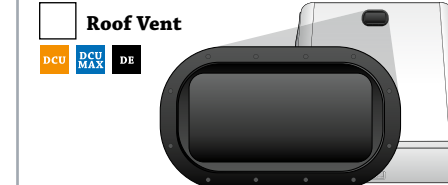

## 4 Choose a Rear Door

A. Choose the rear door and window option that provides optimal accessibility on a daily basis.



Standard 1/2



Standard 1/2 with Window  
 With Security Screens



Double Full

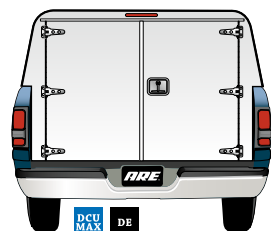

Double Full with Stainless Steel Strap Hinges



Double Full with Windows  
 With Security Screens



Double Full with Window and Stainless Steel Strap Hinges  
 With Security Screens



Single Full

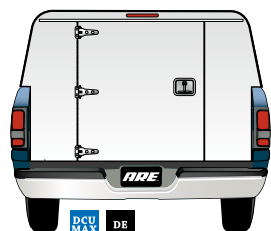

Single Full with Stainless Steel Strap Hinges



Single Full with Window  
 With Security Screens

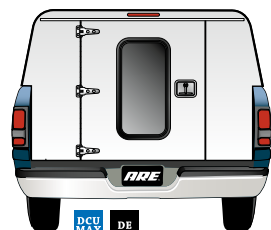

Single Full with Window and Stainless Steel Strap Hinges  
 With Security Screens

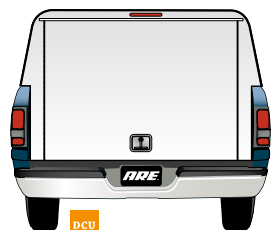

Hatchback Lift



Hatchback Lift with Window  
 With Security Screens



**Add Interior Skin**  
The rear door interior skin matches the exterior aluminum of the cap model.

DCU  DCU MAX  DE

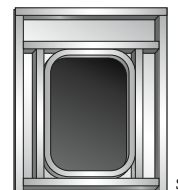

Standard door interior without skin

## 5 Choose a Front Window Option

A. Choose the front window option based on your security, access and visibility needs.



Clear Mitered Picture Window



Clear Mitered Sliding Window



Window with Security Screen



No Window

## 6 Keyless Entry

A. Utilize your truck's key fob to lock/unlock the cap.

Side Doors  Rear Doors  
 DCU  DCU MAX  DE

## 7 Choose a Side Option

A. Choose the side option that fits your needs for access and visibility. If no selection, sides will be solid.

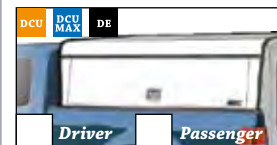

Standard Full Length



Double Doors

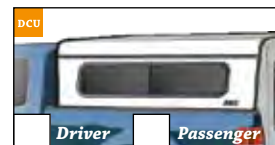

Radius Slider



Full Length with Window  
 With Security Screens



Solid Glass Window

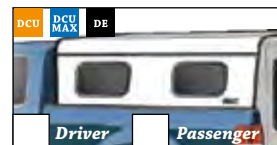

Two Windows Only



Interior Skin  
Interior skin matches the exterior skin of the cap



DCU  
DELUXE COMMERCIAL UNIT™



DCU MAX™



DCU  
DIAMOND EDITION™

## 8 Choose Toolbox and Shelving Options

Toolboxes and Shelving Options apply to all Commercial Aluminum Models

A. Choose an easy access opening, standard toolbox, or one of the special bin storage packages from Ranger Design. DCU® and the DCU Max™ have steel interiors, the Diamond Edition has diamond plate.  
**Note: Fabric liner is not available on toolbox interior.**

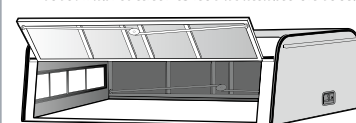

No Toolbox  
 Driver  Passenger

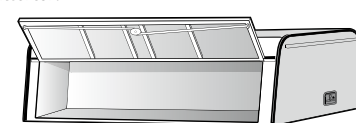

Standard Toolbox  
 Driver  Passenger

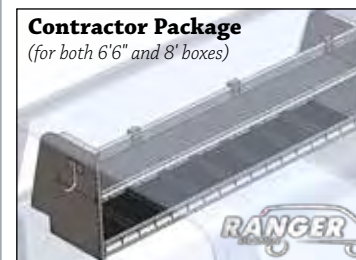

Contractor (Z10-S6 or Z10-S8)  
 Driver  Passenger



Plumber (Z15-S6 or Z15-S8)  
 Driver  Passenger

B. Choose one of the 15 toolbox options shown below, a fold-down shelf for use on the job or choose to have no shelves at all.

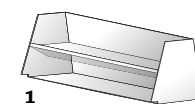

1

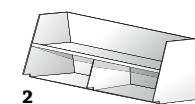

2

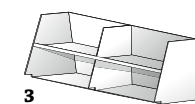

3

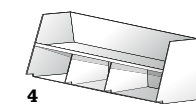

4

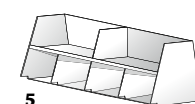

5

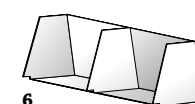

6

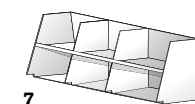

7

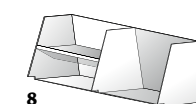

8

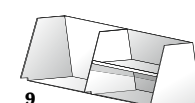

9

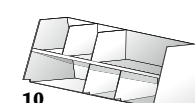

10

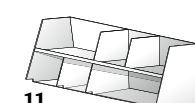

11

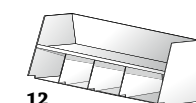

12

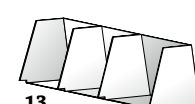

13

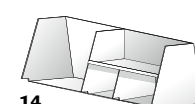

14

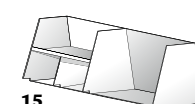

15

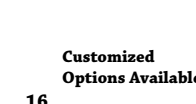

16

Toolbox Shelving Options: Driver Side \_\_\_\_\_ Passenger Side \_\_\_\_\_

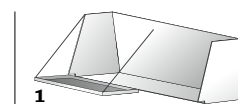

1 Fold-Down Half Shelf Front

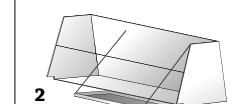

2 Fold-Down Half Shelf Rear

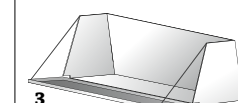

3 Fold-Down Full Shelf

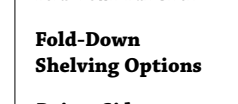

Fold-Down Shelving Options

Driver Side \_\_\_\_\_  
Passenger Side \_\_\_\_\_

Customized Options Available

## 9 Choose a Ladder Rack Option

**DCU DCU MAX DE** Ladder Rack Options apply to all Commercial Aluminum Models  
**A.** Choose an A.R.E. manufactured welded aluminum ladder rack or a commercial-grade aluminum or steel locking ladder rack.

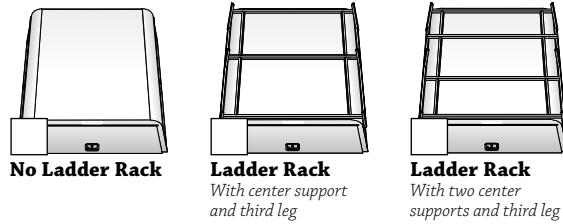

## PRIME DESIGN™



- Double Clamping**
- Driver Side Clamp and Passenger Side Rotational**
- Double Rotational**
- Optional Step Ladder Adaptor**  
Only available for Prime Design models on 8 foot beds.
- 80" AluRack™**  
Aluminum Rack System
- 98" AluRack™**  
Aluminum Rack System
- 120" AluRack™**  
Aluminum Rack System

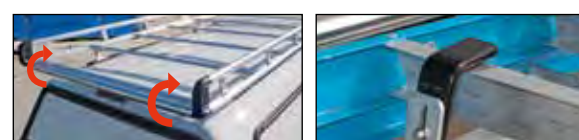

**Easy-Loading Roller System**  
Allows ergonomic loading and unloading of ladders, reducing stress and injuries. One person can easily load the ladders without damaging the vehicle.

**AluRack™ Optional Add-On:**  
Quick Clamp Ladder Lock Attachment  
 **Driver**  **Passenger**

## 10 Choose a Lighting Option

**DCU DCU MAX DE** Lighting options apply to all Commercial Aluminum Models

**A.** Consider where you need light for night visibility, also if you would like the lighting to come on automatically when opening the doors.

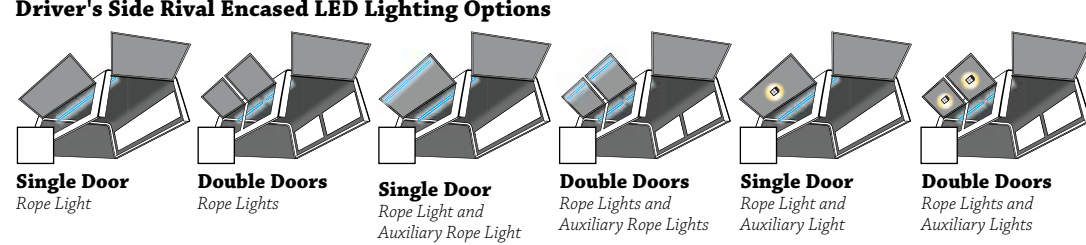

- No Driver Side Rope Light**
- Prop Switch at Driver Side** Will not operate Auxiliary Lights

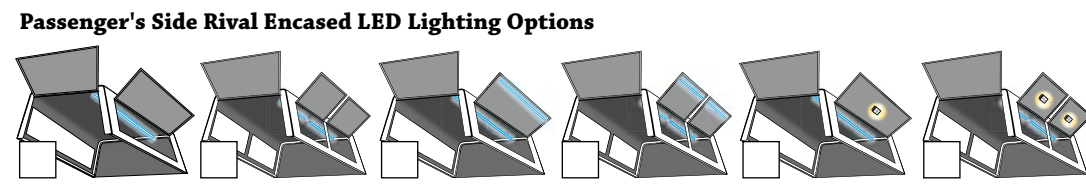

- No Passenger Side Rope Light**
- Prop Switch at Passenger Side** Will not operate Auxiliary Lights

**B.** Consider adding strobe and / or beacon style lighting for increased visibility and safety

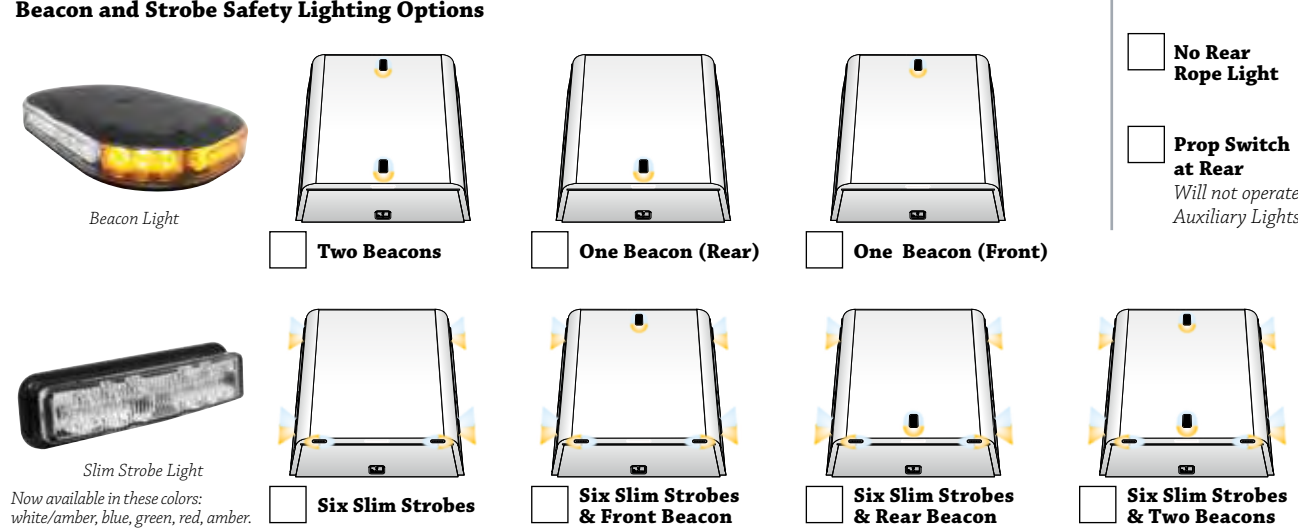

### Rear Door Rival Encased LED Lighting Options

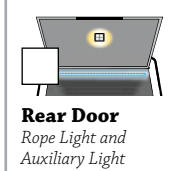
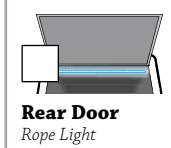

**No Rear Rope Light**

**Prop Switch at Rear**  
Will not operate Auxiliary Lights

## 11 Increase Visibility and Safety with our Back-Up Camera Option



Add back-up camera option

## 12 Choose Rear Door Security Option

**A.** By safely securing your vehicle with Slick Locks puck locks in combination with their patented Spinner 360™ and Weather Shield™, you will be fully equipped with the most preferred vehicle locking system on the market today!



**Slick Locks**  
 **NOTE:** For double full rear doors only

## Commercial Aluminum Cap Warranty

**Certified System**  
 A.R.E. warrants to the original purchaser of Commercial Aluminum truck caps that they are free from defects in structure, materials and workmanship for a period of three years from the date of purchase from an authorized A.R.E. dealership. See the dealership for a copy of the full warranty statement.

## 200+ Possible Cap Options!



With 200 or more variations to choose from, you can create the perfect cap to fit your work needs. Our rugged, fully welded frame construction offers years of durable service, no matter what the weather or job. There's a reason that the A.R.E. DCU Series® is the only truck cap that received a 10 out of 10 rating by Handyman Magazine readers.

Commercial Aluminum Options List	DCU (.035" Thick)	DCU MAX (.063" Thick)	DIAMOND EDITION (.063" Thick)
Standard Metal Skin Colors	White, Light Gray or Black	White	N/A
Painted To Match	•	•	N/A
Black or White Trim	✓	✓	✓
Height	23", 26", 29", 36"	23", 26", 29"	23", 26", 29"
Wedge Height	23"-29", 26"-32", 30"-36"	N/A	N/A
Slanted Sides/Slanted Front	✓	✓	✓
Radius Front/90° Side Walls on 29" and 36" units only	•	N/A	N/A
Acrylic Fabric Liner/Vapor Barrier	•	•	•
Metal Inner Skin	•	•	•
Double Full Doors	•	•	•
Single Full Door	•	•	•
Full Hatchback Lift Door	•	N/A	N/A
Radius Slider Windows	•	N/A	N/A
Solid Glass Window	•	N/A	N/A
Sliding Front Window	•	•	•
Solid Front Window	•	•	•
Roof Vent	•	•	•
Slick Lock	•	•	•
Security Screens	•	•	•
Full Length Side Door	✓	✓	✓
Double Side Door	•	•	•
Tool Bins	•	•	•
Dividers in Tool Bins	•	•	•
Fold-Down Shelves	•	•	•
Brake Light	✓	✓	✓
12 Volt LED Interior Lights	•	•	•
Auto Light Switch on Doors	•	•	•
Aluminum Ladder Rack	•	•	•
Prime Design Ladder Rack	•	•	•
KargoMaster Ladder Rack	•	•	•
AluRack® with Easy Loading Roller	•	•	•
CargoGlide® Cargo Access System	•	•	•
TruckVault® Sliding Drawers	•	•	•
Keyless Entry	•	•	•
Back-Up Camera	•	•	•



# COMMERCIAL FIBERGLASS BUILT TO DO MORE



# HD™

**200 LBS TOOL BOX** **550 LBS ROOF RACK**

## Contractor-Grade Durability

There has never been a stronger and more durable fiberglass truck cap than the A.R.E. HD™. Available for our CX and MX cap profiles, the HD™ features an internal skeleton which triples the weight capacity of the roof rack and side toolboxes. If you test the limits of your truck, and need your cap to be up for the challenge, the A.R.E. HD™ truck cap is the only choice!

**BUILD ONLINE**  
[www.4are.com/fleet/build](http://www.4are.com/fleet/build)

# HD™

## Build the Cap That is Perfect for Your Needs

Follow these 8 steps and check options clearly.

Consult your local A.R.E. dealer for more details or with questions regarding any of the options shown here.

### 1 Choose a Cap Profile

A. Choose the appropriate cap profile for your needs.

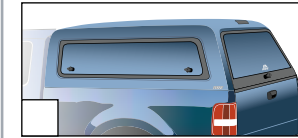

CX Series

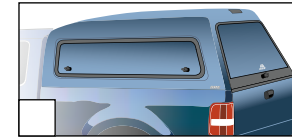

MX Series

### 2 Choose an Interior Finish

A. Choose your preference of our two interior options.



Dark Gray Headliner



Fiberglass Finish

### 3 Choose a Front Window Option

A. Choose the front window option based on your access and visibility needs.



Aluminum Framed Picture Window

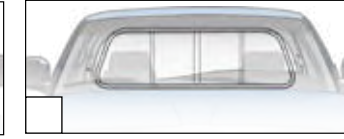

Aluminum Framed Sliding Window

### 4 Choose a Rear Door

A. Choose the rear door and window option that provides the optimal accessibility on a daily basis.

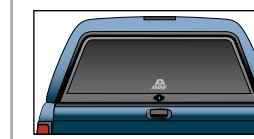

Aluminum Framed Single T Door

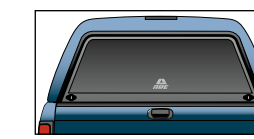

Aluminum Framed Double T Door

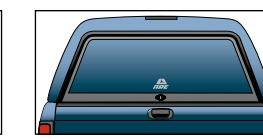

Aluminum Paneled Single T Door

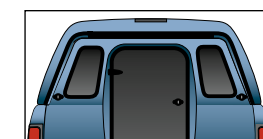

Full Fiberglass Walk-In Door  
*(Consult ARE dealer for availability)*



Aluminum Paneled Double T Door



HD Preferred Option  
Aluminum Paneled Door with Folding T

Add Back-Up Camera Option

### 5 Choose a Side Window Option

A. Choose the side option that fits your needs for access and visibility.



Aluminum Framed Half Slider

Driver  Passenger



Glass Window

Driver  Passenger



Aluminum Paneled Windoor

Driver  Passenger



HD Preferred Option  
Aluminum Paneled Windoor with Folding T

Driver  Passenger



Outdoorsman Vented Windoor

Driver  Passenger



Solid Side Fiberglass

Driver  Passenger

## 6 Choose Toolbox and Shelving Options

A. Choose to have either diamond plate toolbox options or an easy access opening on either side. Note: Toolbox options available with window options only.

- No Toolbox**  
 Driver  Passenger
- Standard Toolbox**  
 Driver  Passenger

HOLDS UP TO 200#



B. Choose the insert option shown below or choose to have no shelves at all.

- 1**  Driver  Passenger

## 7 Choose a Ladder Rack Option

A. Choose a ladder rack that is perfect for your storage needs.

- No Ladder Rack

**HD** HOLDS UP TO 550#



HD Preferred Option

HD Series Ladder Rack



Universal Mounting Tracks

**YAKIMA**



Yakima® CoreBar Roof Rack (Steel)



Add Popular Option: Load Stops

Yakima® JetStream Roof Rack (Aluminum)

### PRIME DESIGN

ErgoRack®



- Double Clamping  Double Rotational  Driver Side Clamp and Passenger Side Rotational

- Optional Step Ladder Adaptor  
 Only available for Prime Design models on 8 foot beds.

AluRack®



- 80" AluRack® Aluminum Rack System  98" AluRack® Aluminum Rack System  120" AluRack® Aluminum Rack System



AluRack® Optional Add-On:  
 Quick Clamp Ladder Lock Attachment

- Driver  Passenger



**Easy-Loading Roller System**  
 Allows ergonomic loading and unloading of ladders, reducing stress and injuries. One person can easily load the ladders without damaging the vehicle.

## 8 Choose a Rival LED Lighting Option

A. Choose your preference of our interior lighting options, including our encased LED rope lights.

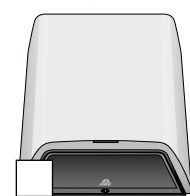

No Interior Lighting

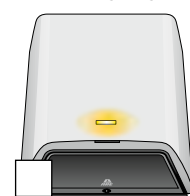

Battery Dome Light

- With Prop Switch

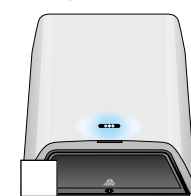

12-Volt LED Dome Light

- With Prop Switch

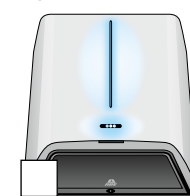

12-Volt LED Dome Light & Center Rope Light

- With Prop Switch

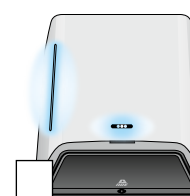

12-Volt LED Dome Light, Driver Side Rope Light

- With Prop Switch

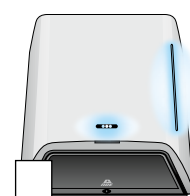

12-Volt LED Dome Light, Passenger Side Rope Light

- With Prop Switch

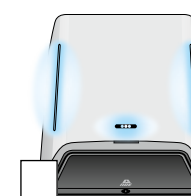

12-Volt LED Dome Light & Dual Rope Lights

- With Prop Switch

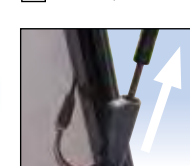

Optional Prop Switch turns your lights on/off, when you open/close your door.

### HD Warranty

A.R.E. warrants to you, the original retail purchaser of an A.R.E. HD Series™, that the body will be structurally free from defects in material and workmanship for as long as you own your cap and the original vehicle. The body includes the fiberglass shell and mounting rails only. A.R.E. warrants to you, the original purchaser, for as long as you own your cap that the exterior paint will not abnormally fade or peel due to material or workmanship defect faster than the original pickup it was installed on by an authorized A.R.E. retail dealer.

The internal skeleton frame will be warranted for three (3) years from your retail date of purchase against failure due to defects in material and workmanship.

All other hardware will be covered under standard A.R.E. fiberglass truck cap warranties.

The A.R.E. HD Series™ has been designed to carry 550 lbs evenly distributed on the HD Series™ roof rack and 200 lbs evenly distributed in each toolbox.

CAUTION: The weight of this product and the weight of the cargo it was designed to carry may be more than your truck was designed to carry on the bed rails. Please consult your truck manufacturer.

WARNING: The use of this product may raise your vehicle's center of gravity, especially when loaded. Higher center of gravity is known to increase the chance of vehicle rollover.

### Trust the Leader

When you purchase our cap for your truck, you have over 600 North American A.R.E. dealerships ready to serve you. Major leasing companies rely on A.R.E. to provide caps and service to thousands of vehicles they own nationwide. You deserve the same peace of mind that they enjoy. See your local authorized A.R.E. dealer today to order the work cap that meets your needs.

# ToolMaster™

**ARE**



## FIBERGLASS CONTRACTOR PACKAGES

ToolMaster™

### Contractor-Grade Durability

For years, A.R.E. has manufactured high-quality fiberglass caps and tonneau covers as well as rugged aluminum units for commercial use. With our Contractor packages, you can have the appearance and style benefits of our fiberglass caps with the security and functionality of our commercial units.



ToolMaster™  
**MX**



ToolMaster™  
**CX**

## Build the Cap That is Perfect for Your Needs

Follow these 8 steps and check options clearly.

Consult your local A.R.E. dealer for more details or with questions regarding any of the options shown here.

### 1 Choose a Cap Profile

A. Choose the appropriate cap profile for your needs.

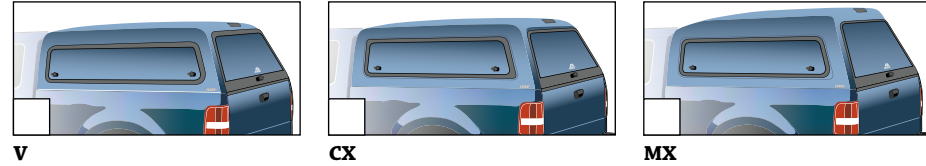

### 3 Choose a Front Window Option

A. Choose the front window option based on your access and visibility needs.

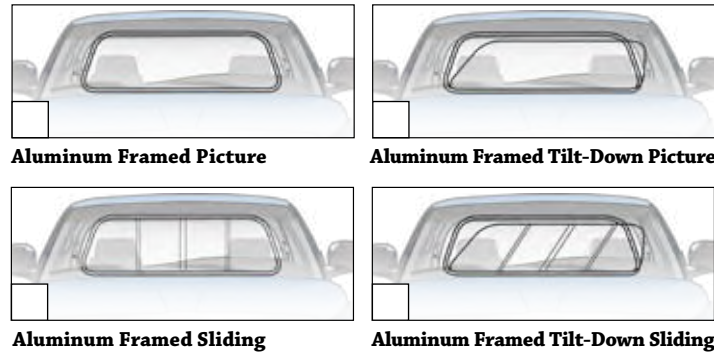

### 5 Choose a Side Window Option

A. Choose the side option that fits your needs for access and visibility.

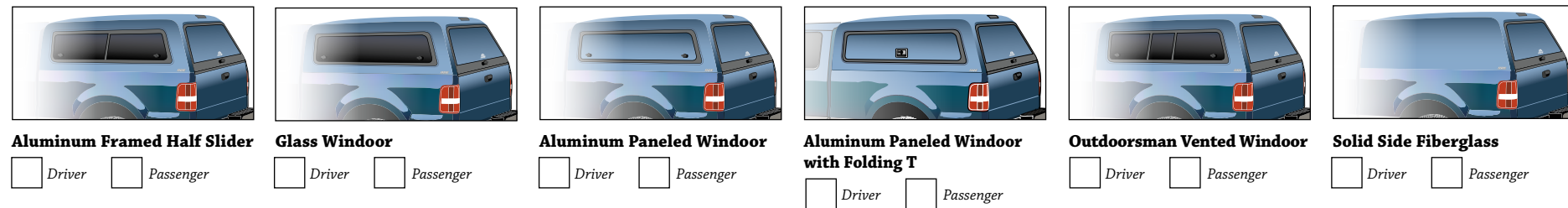

### 2 Choose an Interior Finish

A. Choose your preference of our two interior options.

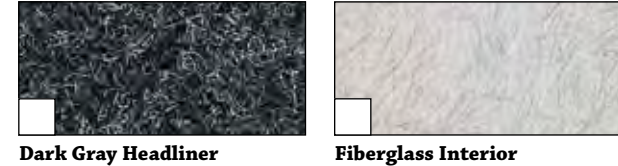

### 4 Choose a Rear Door

A. Choose the rear door and window option that provides the optimal accessibility on a daily basis.

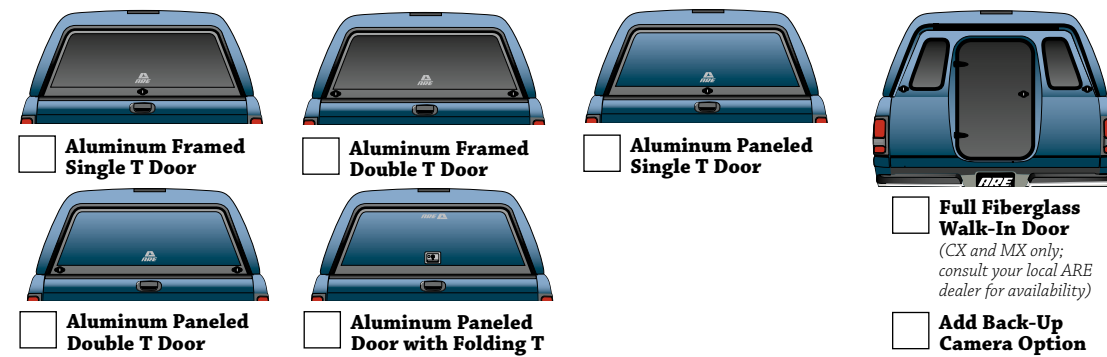

### 6 Choose Toolbox and Shelving Options

A. Choose to have either toolbox storage or an easy access opening on either side. Note: Toolbox options available with windoor options only.

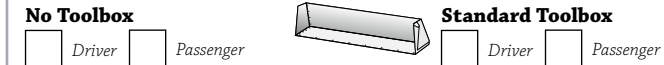

B. Choose the insert option shown below or choose to have no shelves at all.

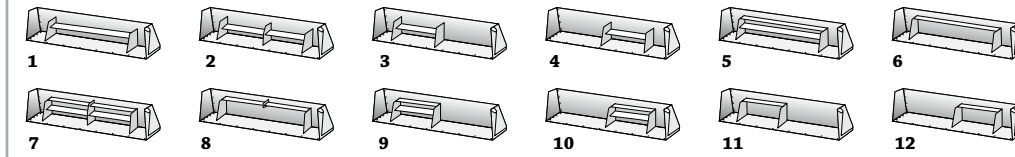

Toolbox Shelving Options Driver Side \_\_\_\_\_ Passenger Side \_\_\_\_\_ Akro Bins

### 7 Choose a Ladder Rack Option

A. Choose a ladder rack that is perfect for your storage needs.



#### PRIME DESIGN

##### ErgoRack®



- Double Clamping
- Double Rotational
- Driver Side Clamp and Passenger Side Rotational
- Optional Step Ladder Adaptor  
Only available for Prime Design models on 8 foot beds.

##### AluRack®



- 80" AluRack® Aluminum Rack System
- 98" AluRack® Aluminum Rack System
- 120" AluRack® Aluminum Rack System



- Driver
- Passenger



**Easy-Loading Roller System**  
Allows ergonomic loading and unloading of ladders, reducing stress and injuries. One person can easily load the ladders without damaging the vehicle.

### 8 Choose a Rival LED Lighting Option

A. Choose your preference of our interior lighting options, including our encased LED rope lights.

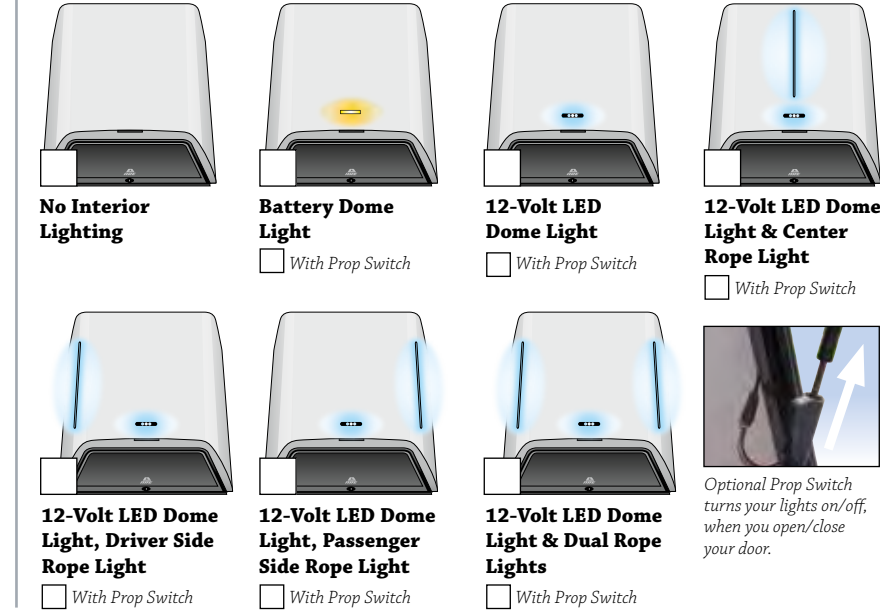

Optional Prop Switch turns your lights on/off, when you open/close your door.

### ToolMaster™ Warranty

A.R.E. warrants to the original purchaser of ToolMaster™ truck caps that they are free from defects in structure, materials and workmanship for lifetime from the date of purchase from an authorized A.R.E. dealership. See the dealership for a copy of the full warranty statement.

### Trust the Leader

When you purchase our cap for your truck, you have over 600 North American A.R.E. dealerships ready to serve you. Major leasing companies rely on A.R.E. to provide caps and service to thousands of vehicles they own nationwide. You deserve the same peace of mind that they enjoy. See your local authorized A.R.E. dealer today to order the work cap that meets your needs.







# TRUCK BED COVERS



# LSII™

## #1 Fiberglass Tonneau

The LSII Series™ offers truck specific styling, premium components and a unique lift assist system for user friendly opening and closing. With a sleek, clean appearance, a proven lock/latch system, a dry and out-of-sight storage area for tools and equipment and better rear visibility when backing up, this industry-leading tonneau cover is a best seller, and for good reason.

The LSII Series™ gives technicians and supervisors who live in gated communities with vehicle restrictions the ability to take their work trucks home.

## DoubleCover™

### LIFTING & RETRACTING TRUCK BED COVER

DoubleCover™ is the industry's first and only truck bed cover that lifts up and retracts for quick and easy bed access.

#### Standard Features

- Aluminum construction with powder coat finish
- Retracts into front canister
- Lifts up with lift assist system
- Center handle with lock
- 550 lb. load rating evenly distributed



Optional Feature: Yakima Cross Bars

## Fusion™

### PAINT-TO-MATCH TRUCK BED COVER

Our newest cover, Fusion™, provides you with a paint-to-match finish in a tri-fold cover. Fold the panels open for quick and easy full bed access or keep them closed for added security and styling

#### Standard Features

- Tri-fold cover
- Paint-to-match panels
- Carpeted under panels
- Low-profile design
- Universal tailgate operation



## 3DL™

### Unparalleled Access

A.R.E.'s Commercial Division is expanding its product line with the new 3DL™. Available for many of today's trucks. This new tonneau cover exemplifies another innovative design from A.R.E. that makes loading and unloading easier for service workers. The 3DL™ turns the bed of the truck into an organized and readily accessible tool container that keeps dust and other elements out.

#### Standard Features

- Two doors on each side
- The entire cover opens effortlessly from the rear of the truck using a hinge system at the front of the cover
- Roller rods for side doors allow for one-hand operation to provide easy access and improved seal
- Paint-to-match
- Design offers the driver excellent rear visibility from the cab of the truck
- Designed to keep products secure and out of sight
- Patented palm handle (black)





## BAKFlip MX4 America's #1 Hard-Folding Cover

The BAKFlip MX4, has new features, including matte-finished cab corner caps, rail-end caps, clamps, and elevator bolts for a more streamlined look and feel. Other MX4 features include an enhanced functionality with pre-molded, die-cut, shock-absorbent bumpers and secure prop rod clips.

### Standard Features

- Premium matte finish
- Rated up to 400 lbs. of evenly distributed weight
- 5-year warranty
- Dual-action tailgate seal



# EXPECT MORE



## Revolver X4

- Matte finish, heavy-duty vinyl
- Unrivaled security
- Matte finish seals & side rails for a finished OEM look



## Revolver X2

- No Velcro® or stitching
- 100% bed access
- Access to stake pocket holes for other accessories



## BAKBox 2

- Fold away utility toolbox
- Works with all BAKFlips and Revolvers
- Includes sliding tray for small items
- Sturdy no-drill clamp-on installation

## TruXport

TruXport is an attractive roll-up truck bed cover that includes top quality features and benefits with a price that won't break the bank. It's easy to install, and operation is simple. Once installed, the pre-set tension control will help maintain the TruXport's great looks all year round.

- Hassle-free installation
- Pre-set tension controls
- Dual latches make it easy to use



## Lo Pro

A sleek, low-profile design is the signature of the Lo Pro. Heavy-duty construction and the patented automatic tension control keep the cover looking great in any weather condition. The Lo Pro mounts inside the rails of the truck bed, providing full access to stake pocket holes for use with additional accessories.

- Industrial-strength, tear-resistant tarp
- Automatic tension control
- Lifetime Warranty

## BEST-SELLING ROLLING COVER





# NEXT GENERATION HARD FOLDING COVERS



## Xceed Seamless and Secure

Introducing Extang's Xceed – a seamless and secure hard folding truck bed cover designed and engineered to greater expectations. This flush mounted, hard-folding cover offers full bed access when open, and adds a seamless and polished look to your truck when closed. Xceed was precisely Extang Engineered to provide excellent coverage while ensuring maximum security and ultimate style.

### Standard Features

- Industry's first rotary release latching system adds an unmatched level of security
- Extang Engineered aluminum panels fold up to the cab for 100% complete bed access
- Superior water management with exclusive enduracoat protective covering

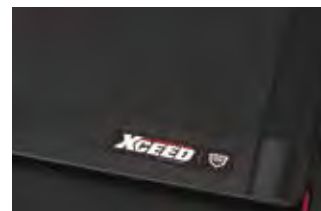

## Solid Fold 2.0

Extang's latest generation of hard tri-fold covers include design elements that you simply will not find anywhere else. The Solid Fold 2.0 now includes exclusive, patented Jaw-Grip and EZ-Lock clamps, EnduraShield panels, revolutionary snap-on perimeter seals, and integrated corner and hinge seals.

- The 2.0 features a tough and durable, dent resistant matte finish
- Most weather resistant hard folding cover on the market
- Compatible with most toolboxes and BackRack applications



## RetraxONE MX

The RetraxONE MX offers a rigid polycarbonate construction provides superior impact resistance and ultimate UV protection allowing the cover to perform in temperatures from -50 to +200°F. The ONE MX combines durable construction with an incredibly resilient matte finish. The RetraxONE MX is key lockable any position.

### Standard Features

- Good looking, low profile design
- Sealed ball-bearing roller system
- Great for 5th wheel towing



## M-Series

Roll-N-Lock M-Series is the most advanced retractable truck bed cover made, has redefined the rules for truck bed security. From its retractable function, which permits opening or closing in seconds, to its rigid, vinyl-over-aluminum laminated construction, this hybrid cover offers everything other covers do not. There are no snaps to manipulate, there is no roll or bundle to lash down or stow, no cross bars to negotiate, no fabric shrinkage to struggle with and, best of all, no worries about the security of cargo. The Roll-N-Lock retractable bed covers by far the most sophisticated and versatile truck bed cover made.





## UnderCover SE

The UnderCover SE is made of UV-protected, scratch resistant ABS composite material. Its stylish lines and rear spoiler are a perfect match for today's modern truck.

- Strong X-Effect structure
- Easy to remove - Only 58 lbs.
- Single locking point
- Also available in Ready-to-Paint

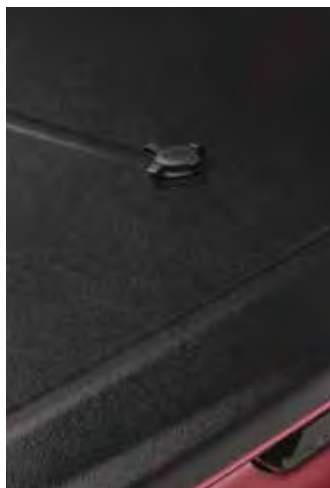

## Elevate

The Elevate Rack System by Truck Hero creates more storage options and overall cargo space for your pickup truck, and allows for full functionality of your cover – be it a roll-up or folding style.

This one of a kind rack system is comprised of very few parts. Simply choose from one of two rack options: the ELEVATE FIXED RACK sits at 28" above the truck bed and is a solid solution to cargo carrying needs. For more versatility, ELEVATE TELESCOPING RACK adjusts from 18" to 28" in height. To install your rack, choose the ELEVATE TS RAILS that matches the length of the truck bed.



**COMPATIBLE WITH MANY TRUCK HERO BRAND TRUCK BED COVERS.**



## BackRack™

The original BACKRACK™ maintains your truck's stylish good looks while providing strength and functionality.

- Function & style for today's trucks
- Park in your garage or underground
- Carry ladders & long loads
- Mount lights or accessories
- Tonneau cover compatible
- No drill on most models
- Secure cargo quick and easy



## Safety Rack

Are cab protection and employee safety your primary concerns? Safety Rack from BACKRACK™ is the solution you need.

- Full Welded Wire Screen
- Ultimate Window Protection
- Carry Ladders & Long Loads
- Mount Lights or Accessories
- Tonneau Cover Compatible
- No drill on most models
- Fleet friendly & quick install



## BedTred Ultra

The BedTred Ultra is a rugged flat work surface that is tough enough to withstand dents and dings while protecting your most fragile cargo from sliding around your truck bed. The BedTred Ultra is a 4-piece zipped liner offering unmatched impact protection.

- Custom molded to fit your truck
- Foldable tailgate gap hinge
- Anti-skid work surface



## BedRug XLT Mat

The XLT Mat is ultra-tough, made of 100% polypropylene that is slip and skid resistant, giving you a flat working surface. The XLT Mat is designed for trucks that have an existing spray-in liner or no bed liner.

- 3/4" thick padded floor gives you impact protection
- Integrated tailgate gap guard hinge keeps debris out
- Waterproof, chemical, & stain resistant



# ACCESSORIES

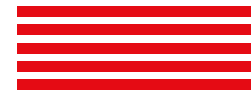

## WeatherBeater™

The rugged & sporty WeatherBeater™ Floor Liners perfectly conform to the contours of your ride and offer un-beatable carpet protection for whatever nature hurls at you.

- Precisely measured for a perfect fit
- Patented FormFit Edge™



## Mud Guards

Custom molded Mud Guards are made from durable, impact resistant all-weather thermoplastic that's as tough as nails.

- Conform perfectly to your fenders
- No drilling required
- Built with maximum width for maximum coverage



## X-ACT Contour®

The Husky Liners® X-act Contour® perfectly matches the contours of your truck or SUV and brings together indestructible strength with a soft, comfortable cushion.

- Precisely measured for a perfect fit
- Patented FormFit Edge™
- StayPut Cleats™ keep liner from shifting around underfoot

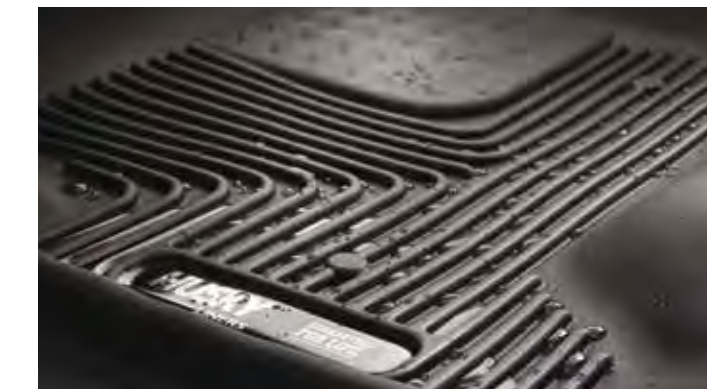

## MudDog™ Mud Flaps

The Husky Liners® MudDog™ Mud Flaps feature a universal design that will fit almost any truck and they're easy to install.

- Impact resistant
- Stainless steel accent or matte black finish

## BedTred Impact Mat

The Impact Mat is made to fit your specific make and model, filling in the ribs and contours of the truck bed to provide a smooth, void free loading surface. The anti-skid TPO surface and padded floor gives you impact protection & is easy on the knees.



## VanRug & VanTred



- Foam backing for cushioning of your cargo
- Slip and skid resistant fiber
- Insulates against noise and heat
- Designed to withstand gas and other chemicals



## Powersteps

GETTING INTO YOUR TRUCK SHOULDN'T FEEL LIKE CLIMBING MOUNT EVEREST.

That's why AMP Research invented POWERSTEP™, the automatic, electric-powered running board that instantly extends when you open your door, and then hides itself safely out of sight when the doors close for improved ground clearance, aerodynamics and appearance. Its handsome design, all-weather performance and legendary reliability set the industry standard. Ditto its industry-leading 5-year/60,000-mile warranty.



## Wheel Well Liners

Rugged Liner's Rear Wheel Well Inner Liners improve and finish the overall look and protect the inner workings of your vehicle from harmful elements.

- Protects against damage from rocks, dirt, salt, road debris and weather elements
- Enhances your truck's appearance by providing a more finished look
- Lifetime warranty

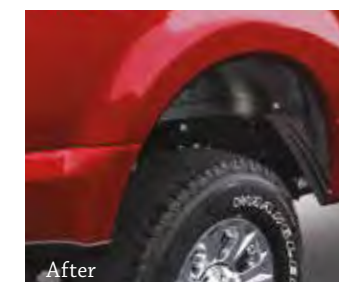

Wheel Well Liner

## Pocket/Rivet Style Smooth Finish Fender Flares

Pocket Style Fender Flares are a Bushwacker original and an off-road icon. They give you the hard-core look of bolt-on flares, with no body-side sheet metal drilling required. Pocket Style Fender Flares are custom-designed for your vehicle to complement oversized tires and high-clearance lift kits. You can mount them right out of the box with their tough, OEM-style matte black finish they're UV protected so they won't chalk. You can also paint them to match or accent the body color for a factory-custom look. Pocket Style Fender Flares are made in the USA from our thick, warp-resistant Dura-Flex 2000 material and tailor-made for added durability and flexibility on the trail. When you need maximum tire coverage with minimum time and effort, it's in the pocket. Pocket Style Fender Flares from Bushwacker.





## Growler

The Growler running board provides a clean yet aggressive look for your vehicle. The tread design allows for ultimate traction in any condition. All aluminum construction offers long lasting durability and strength for all of your vehicle needs. Bolt-on brackets make installation quick and easy. This is a convenient option for work truck and fleet solutions.

- 7' Wide Aluminum board & end caps for long lasting durability
- Available in cab length configuration



## Podium Steps

Hoop step design featuring an all-new expanded and enclosed sure-grip step plate. With a 3" Main tube diameter, this application fits high & tight to the vehicle body for a clean modern style. Fully welded 1-piece construction for strength, long lasting durability & ease of installation! Created from Stainless Steel construction, now available in either a high polish finish, or textured black powder coat.



## Cargo Management Solutions



**CG1000**  
1000 lbs. capacity

75% of the cargo tray length slides out on short bed trucks and 70% on long beds. Sturdy steel frame construction. Real plywood deck with a laminated surface for strength and durability. 6 bearings total, 2 full complement permanently sealed ball bearings, 2 side thrust and 2 powerful needle bearings provide dependable lasting support for the cargo you haul in your CargoGlide.

Industrial 4" high extruded 6061-T6 thick anodized aluminum side rails with a slot style infinitely adjustable tie down track around all 3 sides, and includes 4 adjustable marine-grade tie down eyebolts to make securing cargo easy and versatile.



**CG1500**  
1500 lbs. capacity

75% of the cargo tray length slides out on short bed trucks and 70% on long bed trucks. Sturdy steel frame construction. Real plywood deck with a laminated surface for strength and durability. 8 bearings total, 6 full complement permanently sealed ball bearings and 2 side thrust bearings provide dependable lasting support for the cargo you haul in your CargoGlide.

Industrial 4" high extruded 6061-T6 thick anodized aluminum side rails with a slot style infinitely adjustable tie down track around all 3 sides, and includes 4 adjustable marine-grade tie down eyebolts to make securing cargo easy and versatile.



**CG1500XL**  
1500 lbs. capacity

100% of the cargo tray length slides out for total access to your cargo. Real plywood deck with a laminated surface for strength and durability. 36 bearings total, 4 full complement double row, 16 single row permanently full complement sealed ball bearings and 2 cam follower sealed needle bearings provide dependable lasting support for the cargo you haul in your CargoGlide. This slide also has 14 more sealed side thrust bearings that make it slide easier when used on uneven ground.

Powder coated industrial 4" high extruded 6061-T6 aluminum side rails with a slot style infinitely adjustable tie down track around all 3 sides, and includes 4 adjustable marine-grade tie down eyebolts to make securing cargo easy and versatile. 8" high side extensions on the first 4' of the slide at the cab end helps contain more cargo.



**CG2200HD**  
2200 lbs. capacity

75% of the cargo tray length slides out on short bed trucks and 70% on long beds. Real plywood deck with a laminated surface for strength and durability. 10 bearings total, 4 full complement double row, 6 single row permanently sealed ball bearings provide dependable lasting support for the cargo you haul in your CargoGlide.

Industrial 4" high extruded 6061-T6 thick anodized aluminum side rails with a slot style infinitely adjustable tie down track around all 3 sides, and includes 4 adjustable marine-grade tie down eyebolts to make securing cargo easy and versatile. 8" high side extensions on the first 4' of the slide at the cab end, helps contain more cargo.



**CG2200XL**  
2200 lbs. capacity

100% of the cargo tray length slides out for total access to your cargo. Real plywood deck with a laminated surface for strength and durability. 22 bearings total, 4 full complement double row, 16 single row permanently sealed ball bearings and 2 cam follower sealed needle bearings provide dependable lasting support for the cargo you haul in your CargoGlide.

Powder coated industrial 4" high extruded 6061-T6 aluminum side rails with a slot style infinitely adjustable tie down track around all 3 sides, and includes 4 adjustable marine-grade tie down eyebolts to make securing cargo easy and versatile. 8" high side extensions on the first 4' of the slide at the cab end, helps contain more cargo.

# TRUCKVAULT® 2-Drawer Bed Storage System



- Comes standard with two drawers, and folding t-handle lock
- No-drill turn buckle installation
- 5/8" medium density overlay (MDO) top surface will support up to 2,000 lbs. on top of TruckVault®
- Exterior finish: dark gray polypropylene, matches A.R.E. cap or cover carpeted interior option
- Interior finish: drop-in ¼" rubber mat
- Limited lifetime warranty – see your local retailer or [www.truckvault.com](http://www.truckvault.com) for complete warranty information
- Approximate width: 39–48" based on bed width
- Approximate length: 46–94"+ based on bed length
- Approximate height: 10.5–12.5" based on truck model
- Standard drawer depth: 8"
- Each drawer holds up to 250 lbs.



## Standard Accessories



Folding T-handle lock



No-drill turn buckle installation



Drop-in rubber mat drawer interior

## Additional Accessories



Drawer dividers (front to back and side to side)



Top rubber mat



LED light (battery)



Tie down rails with cargo rings

## Van Applications Available

All builds are custom, contact your fleet representative for build and pricing.



## Safety Lighting



**STROBE**  
LUMENS: 300 AMBER  
LUMENS: 700 WHITE  
Remote or switch controlled



**BEACON**  
LUMENS: 1700  
Permanent or Magnetic Mount

**LUMALARM**  
DECIBELS: 97  
LUMENS: 200 AMBER



## Work Lights



**ROUND**  
LUMENS: 1400



**LED HYBRID**  
LUMENS: 2500



## Rival Lighting by A.R.E

Rival by A.R.E. is a full LED lighting product line featuring factory-installed options on an A.R.E. product, as well as individually offered lighting to allow you to customize your fleet vehicles. To learn more information about Rival contact your Truck Hero fleet representative or visit [www.4are.com/product/rival](http://www.4are.com/product/rival).



## Cube & Flush Mount Lights



**CUBE**  
LUMENS: 1080  
Spot or Flood



**FLUSH MOUNT**  
LUMENS: 1080  
Spot or Flood